

Throttle Modules / Throttle and Check Modules

Used as pilot choke valves for solenoid controlled pilot operated directional valves and pilot operated directional valves.



Graphic Symbols

Valve Size	Throttle Modules		Throttle and Check Modules	
	Standard Type	With Check	Standard (Metre-out) Type	Metre-in Type
01	<p>Solenoid Operated Directional Valve</p> <p>P A B T TC1G-01</p>		<p>Solenoid Operated Directional Valve</p> <p>P A B T TC2G-01</p>	
03	<p>Solenoid Operated Directional Valve</p> <p>P A B T TC1G-03</p>	<p>Solenoid Operated Directional Valve</p> <p>P A B T TC1G-03-C</p>	<p>Solenoid Operated Directional Valve</p> <p>P A B T TC2G-03</p>	<p>Solenoid Operated Directional Valve</p> <p>P A B T TC2G-03-A</p>

Specifications

Model Numbers	Nominal Flow L/min (U.S.GPM)	Max. Operating Pressure MPa (PSI)	Approx. Mass kg (lbs.)
TC1G-01-40/4090	30 (7.9)	25 (3630)	0.6 (1.3)
TC2G-01-40/4090			0.65 (1.4)
TC1G-03-*40/4090	80 (21.1)		1.6 (3.5)
TC2G-03-*40/4090			1.8 (4.0)

Model Number Designation

F-	TC1	G	-03	-C	-40	*
Special Seals	Series Number	Type of Mounting	Valve Size	Valve Type	Design Number	Design Standards
F: Special Seals for Phosphate Ester Type Fluids (Omit if not required)	TC1: Throttle Module	G: Gasket Mounting	01	None: Std. Type	40	None: Japanese Std. "JIS" and European Design Std. 90: N. American Design Std.
	TC2: Throttle and Check Module			None: Std. (Metre-Out) Type		
	TC1: Throttle Module	G: Gasket Mounting	03	None: Std. Type C: With Check Valve	40	
	TC2: Throttle and Check Module			None: Std. (Metre-Out) Type A: Metre-in Type		

D
Throttle Modules
Throttle and Check Modules

■ Attachment

● Mounting Bolts

If mounting bolts are necessary, order suitable ones selected from the table below. If mounting bolts from other companies are used, their strength must be 8.8 or up ISO standards.

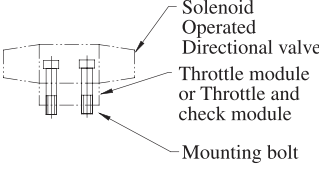
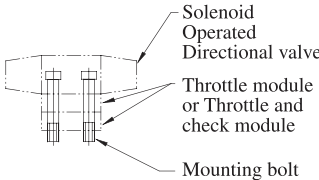
Solenoid Operated Directional Valve	Valve Model Numbers	Socket Head Cap Screw		Qty.
		Japanese Std. "JIS" & European Design Std.	N. American Design Std.	
	TC*G-01	M5 × 70 Lg.	No. 10-24 UNC × 2-3/4 Lg.	4
	TC*G-03	M6 × 70 Lg.	1/4-20 UNC × 2-3/4 Lg.	4
	TC*G-01	M5 × 95 Lg.	No. 10-24 UNC × 3-3/4 Lg.	4
	TC*G-03	M6 × 100 Lg.	1/4-20 UNC × 4 Lg.	4

■ Instructions

● Flow adjustment

Slacken the lock nut and turn the flow adjustment screw clockwise caused the flow rate to decrease
After adjustment, be sure to tighten the lock nut.

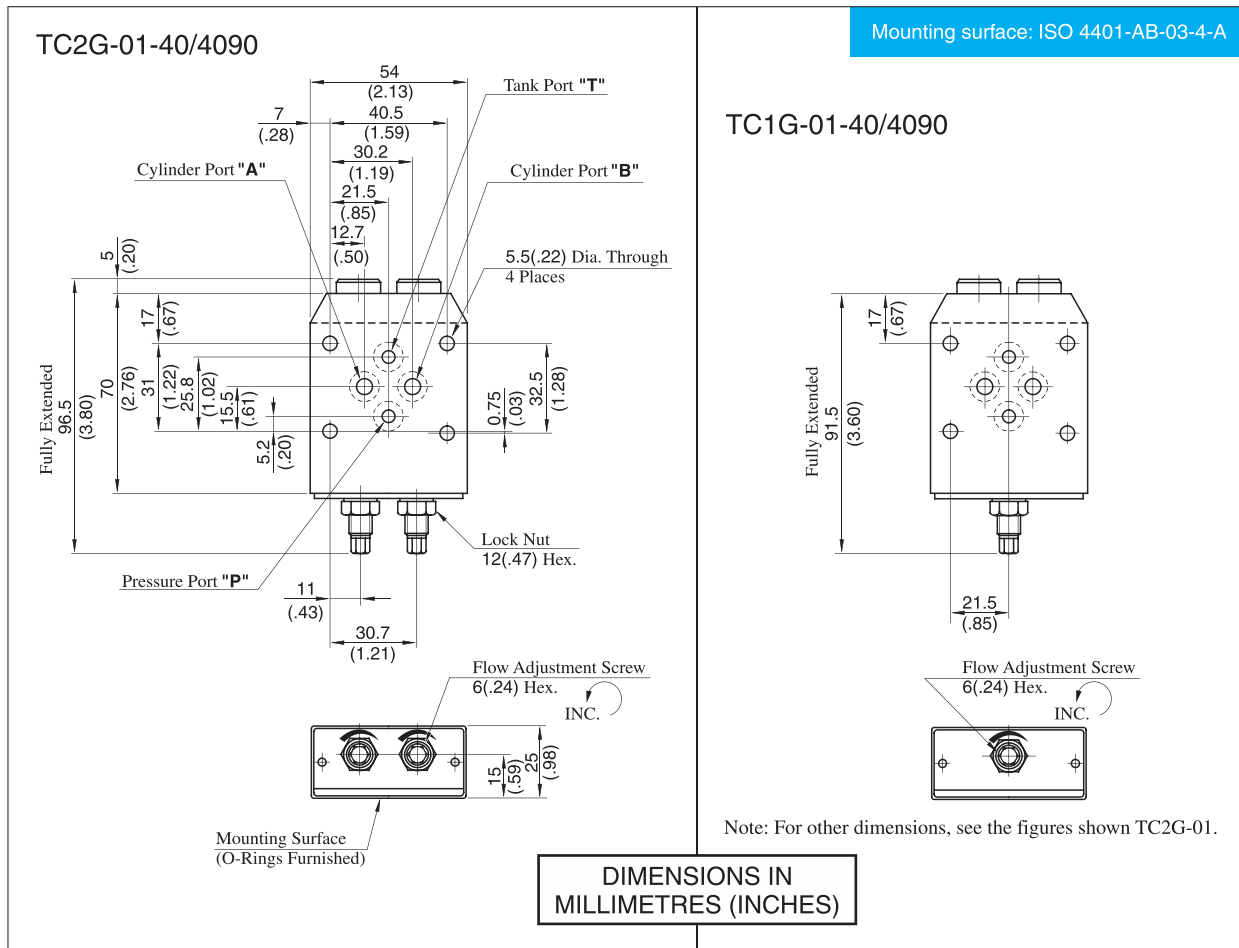

TC2G-03-40/4090
 TC2G-03-A-40/4090

Mounting surface: ISO 4401-AC-05-4-A

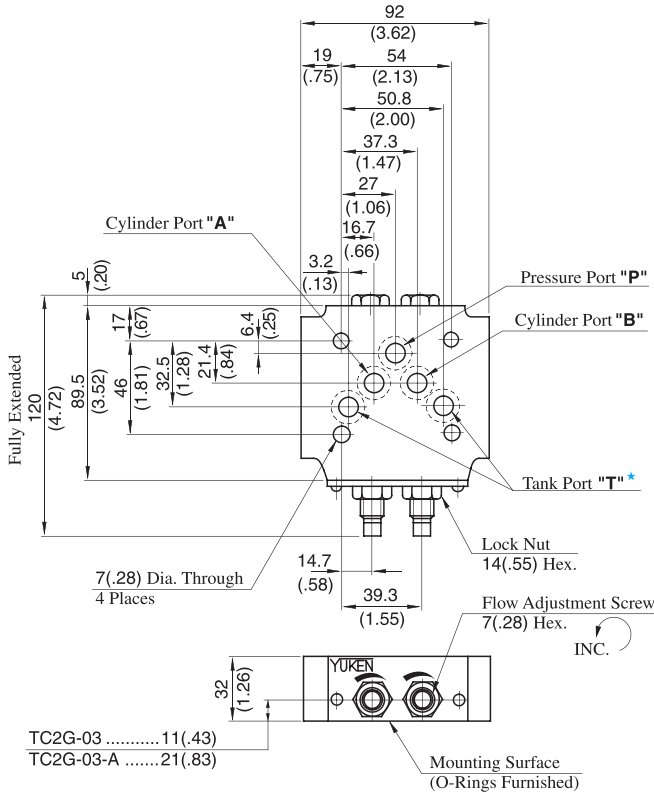

★ With standard sub-plates, the left one of the two tank ports "T" is used but either one may be used.

DIMENSIONS IN
 MILLIMETRES (INCHES)

TC1G-03-40/4090
 TC1G-03-C-40/4090

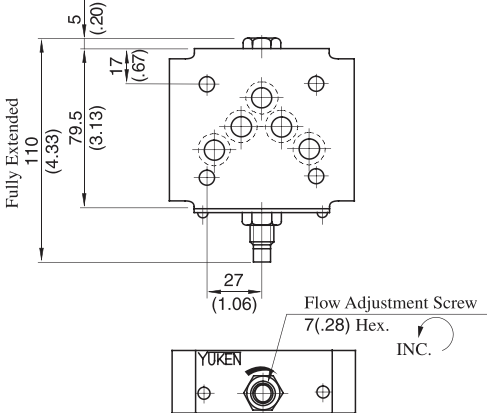

Note: For other dimensions, see the figures shown TC2G-03.

D
 Throttle Modules
 Throttle and Check Modules

Hydraulic Fluid: Viscosity 35 mm²/s (164 SSU) , Specific Gravity 0.850

■ Metred Flow vs. Adjustment Revolutions

■ Pressure Drop

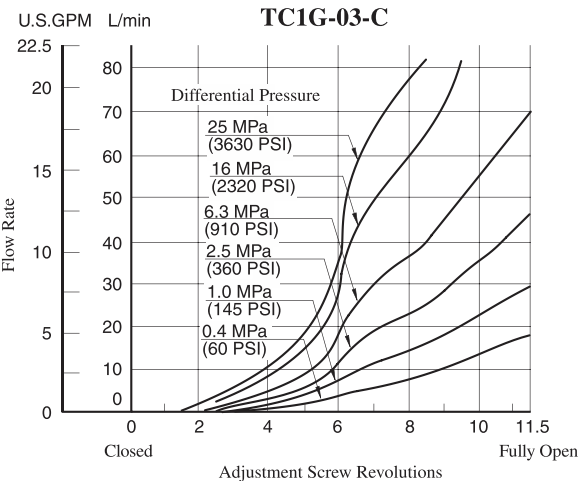
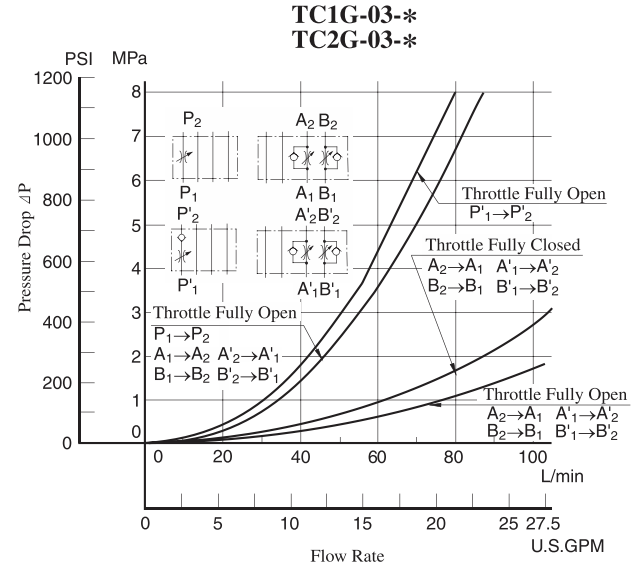
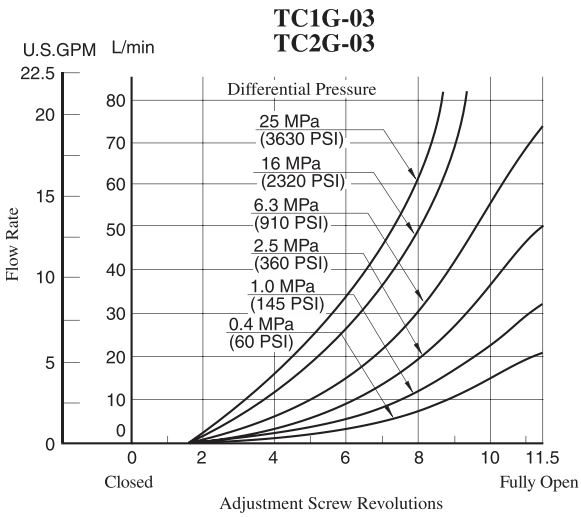
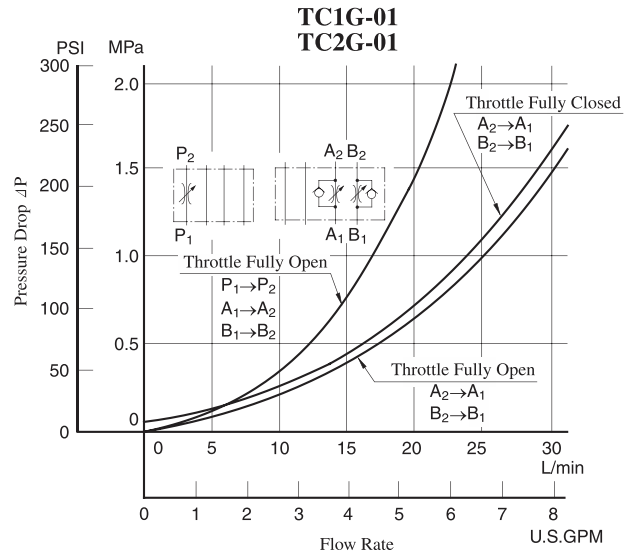
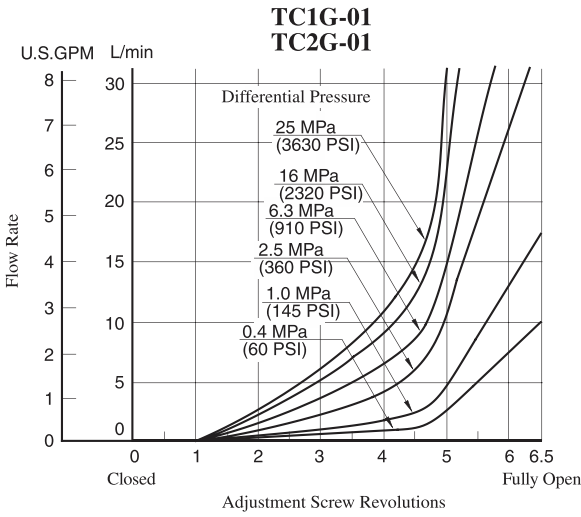

- For any other viscosity, multiply the factors in the table below.

Viscosity	mm ² /s	15	20	30	40	50	60	70	80	90	100
		SSU	77	98	141	186	232	278	324	371	417
Factor		0.81	0.87	0.96	1.03	1.09	1.14	1.19	1.23	1.27	1.30

- For any other specific gravity (G'), the pressure drop (ΔP') may be obtained from the formula below.

$$\Delta P' = \Delta P (G'/0.850)$$

List of Seals

TC1G-01-40/4090
TC1G-03-*-40/4090

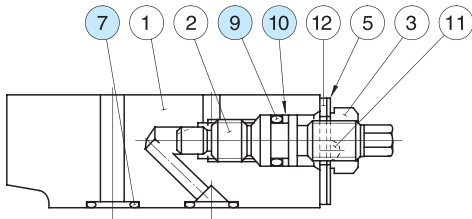

TC1G-01

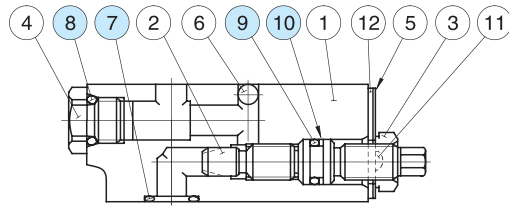

TC1G-03

List of Seals

Item	Name of Parts	Part Numbers		Qty.
		TC1G-01	TC1G-03	
7	O-Ring	SO-NB-P9	SO-NB-A014	5★
8	O-Ring	—	SO-NB-P10	1
9	O-Ring	SO-NA-P7	SO-NA-P9	1
10	Back Up Ring	SO-BB-P7	SO-BB-P9	1

★ With TC1G-01, four O-Rings, Item ⑦, are used.

Note: When ordering the seals, please specify the seal kit number from the table right

List of Seal Kits

Valve Model Numbers	Seal Kit Numbers
TC1G-01	KS-TC1G-01-40
TC1G-03	KS-TC1G-03-40
TC1G-03-C	

TC2G-01-40/4090
TC2G-03-*-40/4090

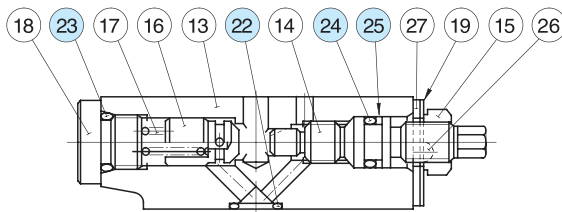

TC2G-01

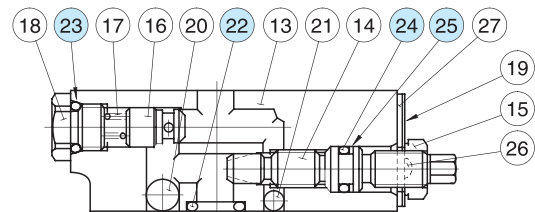

TC2G-03

List of Seals

Item	Name of Parts	Part Numbers		Qty.
		TC2G-01	TC2G-03	
22	O-Ring	SO-NB-P9	SO-NB-A014	5★
23	O-Ring	SO-NB-P10	SO-NB-P10	2
24	O-Ring	SO-NA-P7	SO-NA-P9	2
25	Back Up Ring	SO-BB-P7	SO-BB-P9	2

★ With TC2G-01, four O-Rings, Item ②, are used.

Note: When ordering the seals, please specify the seal kit number from the table right

List of Seal Kits

Valve Model Numbers	Seal Kit Numbers
TC2G-01	KS-TC2G-01-40
TC2G-03	KS-TC2G-03-40
TC2G-03-A	