



OBE (On-Board Electronics) Type High Response Proportional Electro-Hydraulic Directional and Flow Control Valves (Two Stage Type)

ELDFHG-04EH-280-*-XY--**-10**

ELDFHG-06EH-*-XY--**-10**

Release of New Products

We are pleased to announce the release of high flow rate and two stage type valves as an addition to our highly appreciated product series: OBE type direct operated and high response proportional electro-hydraulic directional and flow control valve series.



■ Features

● Simple Operation and User-Friendliness

The addition of OBE to the ELDFHG series valves for simplified wiring offers simple operation and user-friendliness. Only with 24 V DC power supply and command signal input, the valves allow highly accurate and fast operation of hydraulic systems.

● Response Characteristics Equivalent to Simple Servo Valves

A closed loop structure provided by incorporating a differential transformer for spool position detection enables feedback control, achieving high response equivalent to a simple servo valve.

● High Accuracy

The valves have a hysteresis of 0.1% or less, achieving high accuracy equivalent to that of servo valves. The 2% overlap type (spool type: 3C2L) with linear no-load flow characteristics is suitable for position and pressure control in machinery/equipment.

● Safety and Reliability

The valves support a fail-safe function to ensure safe operation in the event of electric failure (power failure, power cable disconnection, etc.).

● High flow rate

No.	Series Number	Rated Flow L/min	Measurement Conditions
1	ELDFHG-04EH	280	ΔP = 1 MPa 4-Way Valve
2	ELDFHG-06EH	350/500	

■ JIS Graphic symbols

● Spool type “3C2”, “3C2P”, “3C2L”

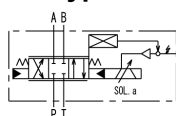

Internal pilot
Internal drain type

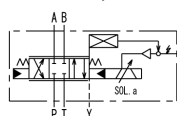

Internal pilot
External drain type

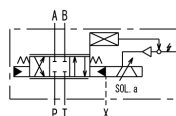

External pilot
Internal drain type

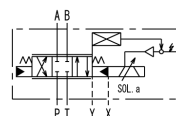

External pilot
External drain type

● Spool type “3C40”

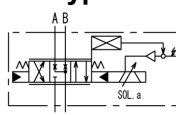

Internal pilot
Internal drain type

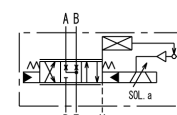

Internal pilot
External drain type

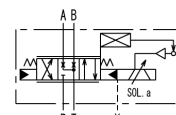

External pilot
Internal drain type

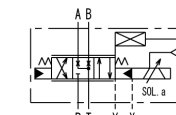

External pilot
External drain type

* “SOL.a” is for the model 04EH.
For the model-06EH, it is “SOL.b”

■ Specifications

Model Number			ELDFHG-04EH	ELDFHG-06EH-350	ELDFHG-06EH-500
Rated Flow $\Delta P=1$ MPa (4-Way Valve) $\Delta P = 0.5$ MPa per Land	L/min		280	350	500
Max. Operating Pressure	MPa		35		31.5
Proof Pres. at Return Port*1	External Drain T Port	MPa	31.5	35	25
	External Drain Y Port	MPa	21		
	Internal Drain T & Y Port	MPa	21		
Pilot Pressure*2	MPa	1.5 to 25			
Pilot Flow Rate*3	L/min		11 or more	12 or more	16 or more
Internal Leakage Supply Pressure: 14MPa Pilot Pressure: 14MPa Fluid Viscosity: 32mm ² /s	Pilot Valve	L/min	1.8 or less		
	Main Valve L/min	3C2	0.8 or less	0.9 or less	1.0 or less
		3C40	1.6 or less	1.8 or less	1.8 or less
		3C2P	6.8 or less	7.0 or less	8.0 or less
		3C2L	2.1 or less	2.5 or less	2.5 or less
Hysteresis		0.1% or less			
Step Response (0 <=> 100%) V Pilot Pressure: 14MPa (Typical Rating)*4	ms		20	20	22
Frequency Response $\pm 25\%$ Amplitude Pilot Pressure: 14MPa (Typical Rating)*4	Phase: -90°	Hz	51	50	45
	Gain: -3 dB	Hz	56		
Vibration Proof*5	m/s ²		100		
Protection			Equivalent to IP65		
Ambient Temperature	°C		0 to +50		
Spool Stroke to Stops	mm		± 5	± 5	± 7
Spool End Area	cm ²		7	8	8
Current	A		2 (MAX. 3)		
Coil Resistance at 20 °C	Ω		3		
Approx. Mass	kg		13	19	
Electric Connection			6 + PE Connector [EN 175201 Part 804]		

*1: Pressure at the return port should be the actual supply pressure or less.

*2: Supply pressure for the pilot valve should be within the range described above and should also be 60% of the actual main valve supply pressure or more.

*3: Pilot flow is calculated with the above step response time at pilot pressure 14 MPa.





*4: This value is measured on a per-valve basis under the conditions described above; it may differ depending on the actual circuit and operating conditions.

*5: There are restrictions on the mounting position. See page 4 for details.

■ Details of the valve fail-safe function

With reference to the information given below, select the option for the fail-safe function according to the use of applications.

A separate safety circuit should be provided if the hydraulic actuator must be reliably held or stopped.

No.	Model Number	Fail-Safe Function	
		Spool Position	Function
1	ELDFHG-*EH*-3C2-XY-**-C	Neutral	All Ports Blocked 
2	ELDFHG-*EH*-3C40-XY-**-C	Neutral	A, B, T Connection 
3	ELDFHG-*EH*-3C2L/3C2P-XY-**-A	Valve Opening: 10%	PABT Position 
4	ELDFHG-*EH*-3C2L/3C2P-XY-**-B	Valve Opening: 10%	PBAT Position 

* The fail-safe function's activation time depends on the electric and hydraulic conditions.

■ Model number designation

ELDFHG	- 04	EH	- 280	- 3C2P	- XY	-E	T	- C	-D	-10
Series Number	Valve Size	Amplifier Type	Rated Flow L/min $\Delta P=1$ MPa (4-Way Valve)	Spool Type	Direction of Flow	Pilot Type	Drain Type	Fail-Safe Function	Input Signal/Spool Travel Monitoring	Design Number
ELDFHG: Two Stage Type High Response Type Proportional Electro-Hydraulic Directional and Flow Control Valves (Sub-plate Mounting)	04	EH: OBE Type	280: 280	3C2: 10% Overlap 3C40: A, B, T Connection	XY: Meter-In /Meter-Out	None: Internal Pilot E: External Pilot	None: External Drain T: Internal Drain	C: Neutral	D: Voltage Signal ± 10 V (PABT Flow with Positive Input) E: Current Signal 4 to 20 mA (PABT Flow with 12 to 20 mA Input) F: Current Signal ± 10 mA (PABT Flow with Positive Input)	10
				3C2P: Zero Lap (Dual Flow Gain) 3C2L: 2% Overlap (Linear Flow Gain)						
	06		350: 350 500: 500	3C2: 10% Overlap 3C40: A, B, T Connection						
				3C2P: Zero Lap (Dual Flow Gain) 3C2L: 2% Overlap (Linear Flow Gain)						

* Phosphate ester type fluids are also supported. When phosphate ester type fluids are used, prefix "F-" to the model number because the special seals (fluororubber) are required to be used.

■ Electrical specifications

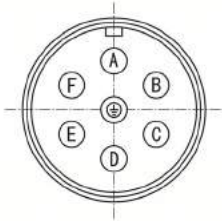

Input Signal		Voltage Signal "D"	Current Signal "E"	Current Signal "F"
Pin A	Power Supply	24 V DC (21.6 - 26.4 V DC Included Ripple), 75 VA or more		
Pin B		0 V		
Pin C	Signal Common	COM (0 V)		
Pin D	Input (+)(Differential) ²	0 - ± 10 V $R_i \geq 50$ k Ω	4 - 20 mA $R_i=200$ Ω	0 - ± 10 mA $R_i=200$ Ω
Pin E	Input (-)(Differential) ²			
Pin F	Spool Travel Monitoring	0 - ± 10 V $R_L \geq 10$ k Ω	4 - 20 mA $R_L=100 - 500$ Ω^{*1}	0 - ± 10 mA $R_L=100 - 500$ Ω^{*1}
Pin \oplus	Protective Earth	—		

*1: The recommended load resistance is 200 Ω .

*2: Differential input signals can be used only for the valves with the voltage signal specifications of ± 10 V.

● I/O Signal Characteristics

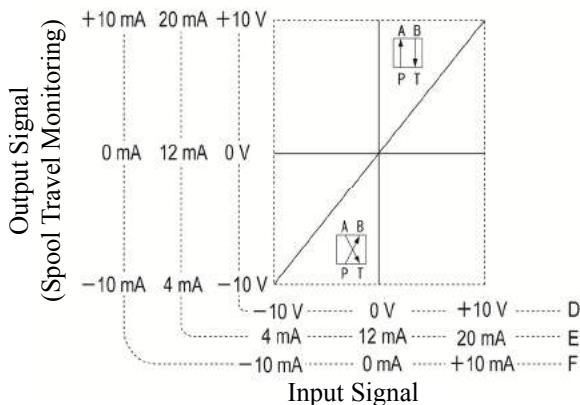

■ Block diagram

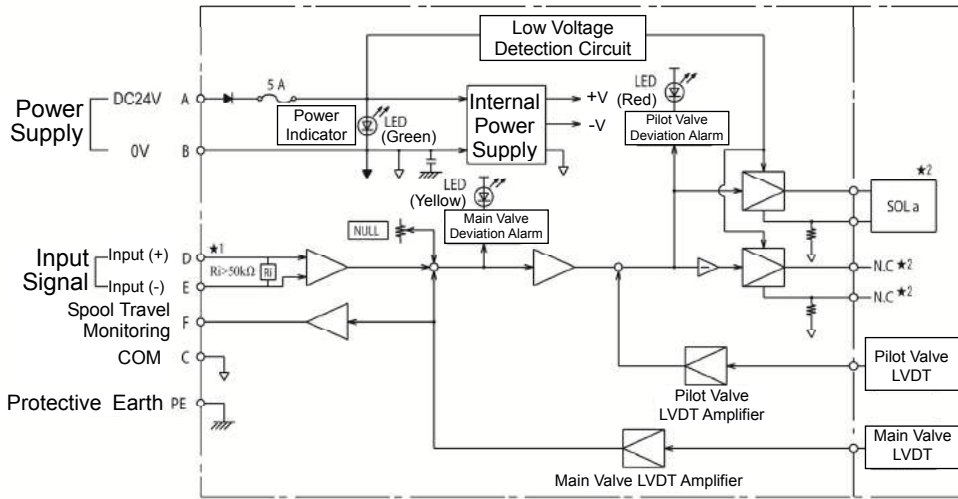

*1: The input stage for the current signal "E" and "F" is as follows.

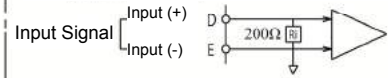

*2: The solenoid name is for the model ELDFHG-04EH. The name for the model ELDFHG-06EH is as follows.

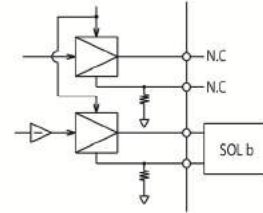

■ Accessories

● Mounting bolt

Valve Model Number	Mounting Bolt	Qty	Tightening Torque N•m
ELDFHG-04EH	Hexagon Socket Head Cap Screw: M6 × 55L	2	12.9 to 15.9
	Hexagon Socket Head Cap Screw: M10×60L	4	60.6 to 74.1
ELDFHG-06EH	Hexagon Socket Head Cap Screw: M12×85L	6	104 to 127

■ Mounting position

Mount the valve with the angle of the axis line L-L' within about $\pm 15^\circ$ from the horizontal plane as shown in the right figure. When the principal vibration direction is consistent with the axial direction of the spool, the spool may malfunction due to external force. Make sure that the principal vibration direction is not consistent with the axial direction of the spool.

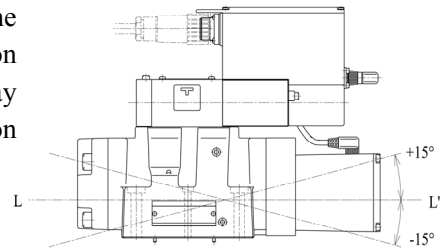

■ Range of fail-safe function

ELDFHG-04EH

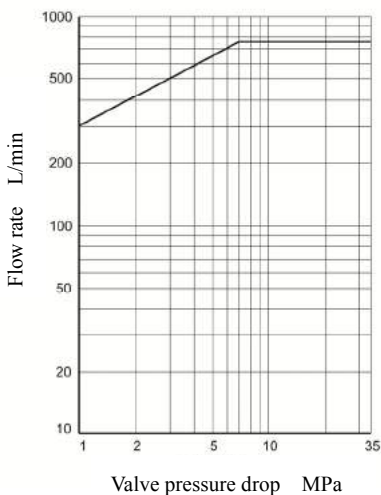

ELDFHG-06EH

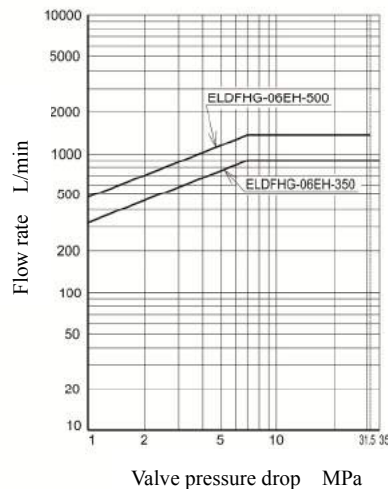

ELDFHG-04EH-280-*-XY-**-*-*-10

Mounting Surface: Conforming to ISO 4401-07-06-0-94

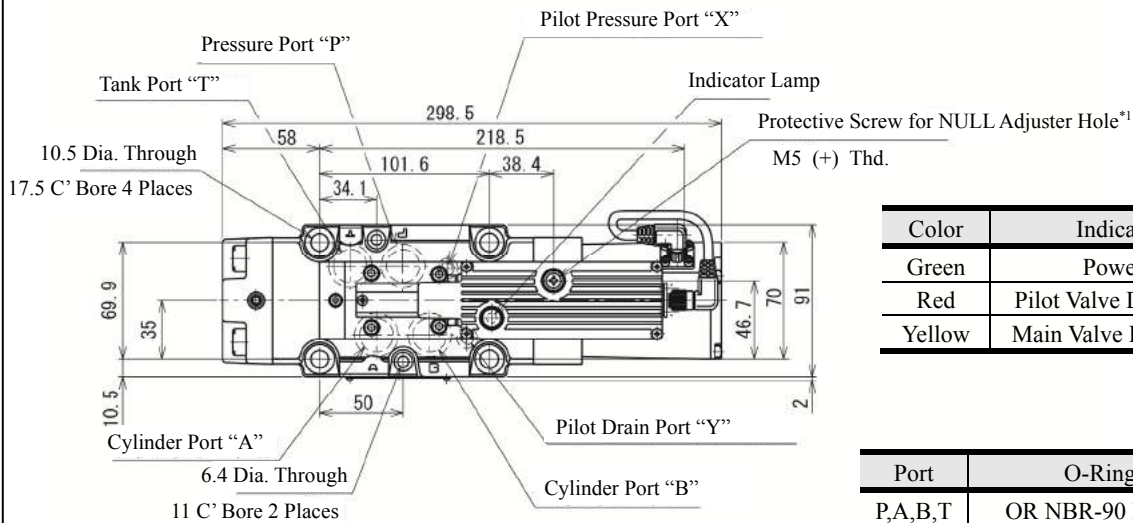

Color	Indicator Lamp
Green	Power Supply
Red	Pilot Valve Deviation Alarm
Yellow	Main Valve Deviation Alarm

Port	O-Ring	Qty
P,A,B,T	OR NBR-90 P22-N	4
X,Y	AS568-012(NBR-90)	2

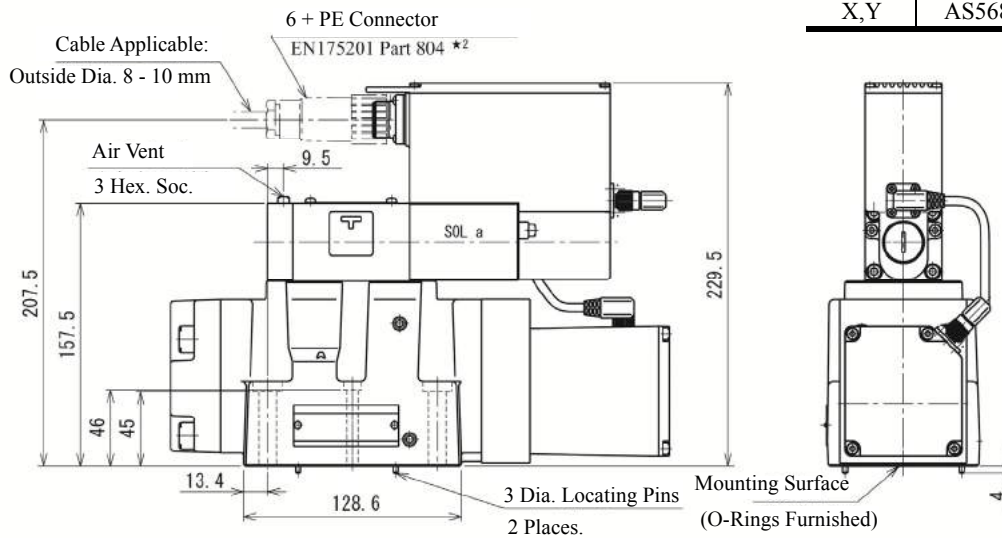

*1. For NULL adjustment, remove the protective screw and turn the trimmer behind the screw. After adjustment, be sure to attach the protective screw.

*2. The 6 + PE connector is not included with the valve. Prepare it separately.
YUKEN parts number: TK290457-1

• Dimensions of mounting surface

Prepare the mounting surface as shown below.

The mounting surface should have a good machined finish, e.g. surface roughness of 6-S.

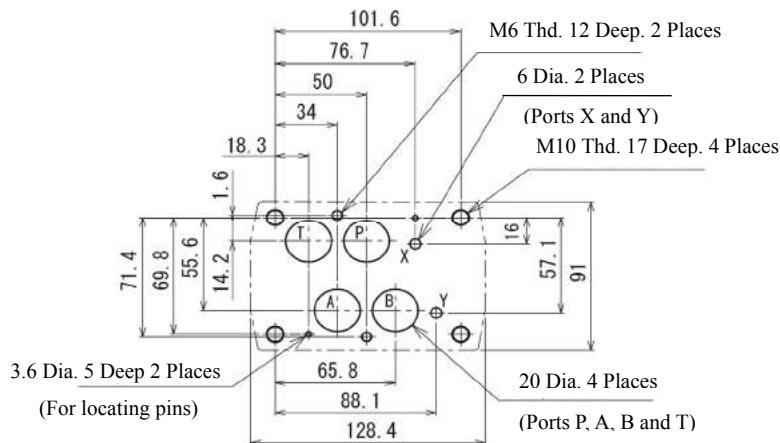

ELDFHG-06EH-350/500-※-XY-※※-※-※-10

Mounting Surface: Conforming to ISO 4401-08-07-0-94

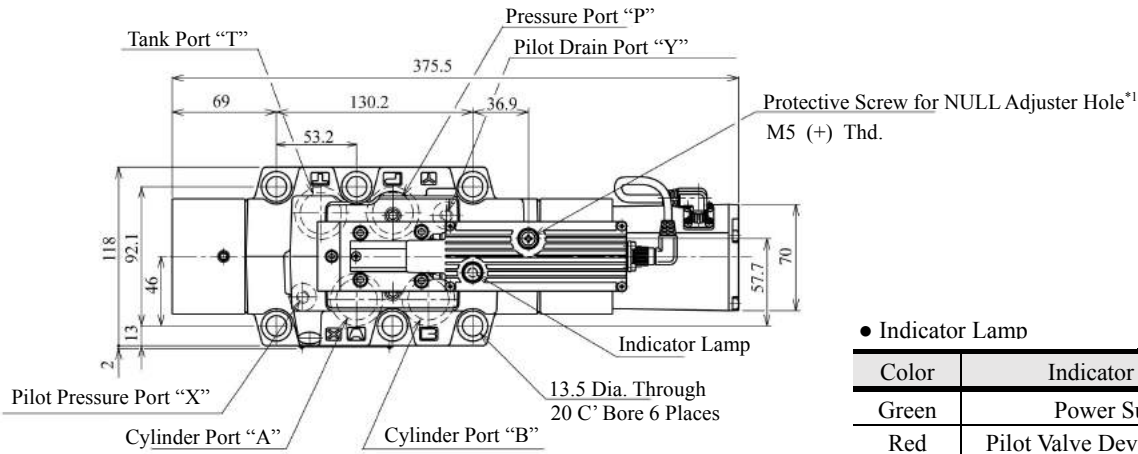

● Indicator Lamp

Color	Indicator Lamp
Green	Power Supply
Red	Pilot Valve Deviation Alarm
Yellow	Main Valve Deviation Alarm

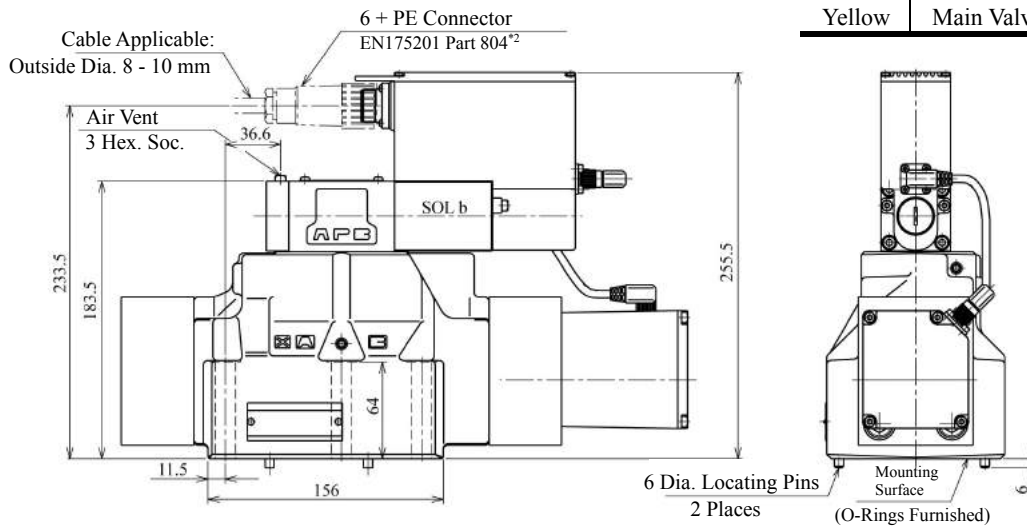

● O-Ring

Port	Model Number	O-Ring	Qty
P,A,B,T	ELDFHG-06EH-350	AS568-123(NBR-90)	4
	ELDFHG-06EH-500	AS568-126(NBR-90)	4
X,Y	ELDFHG-06EH-350/500	OR NBR-90 P14-N	2

*1. For NULL adjustment, remove the protective screw and turn the trimmer behind the screw. After adjustment, be sure to attach the protective screw.

*2. The 6 + PE connector is not included with the valve. Prepare it separately. YUKEN parts number: TK290457-1

● Dimensions of mounting surface

Prepare the mounting surface as shown in the right figure. The mounting surface should have a good machined finish, e.g. surface roughness of 6-S.

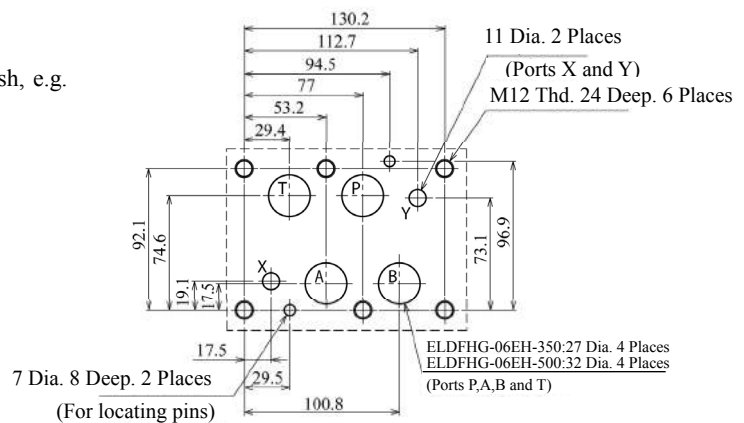

■ No-load flow characteristics

- <Conditions>
- Valve pressure difference: 1 MPa (4-Way Valve/Pressure difference per land: 0.5 MPa)
 - Viscosity: 30 mm²/s

ELDFHG-04EH-280-3C2L

ELDFHG-04EH-280-3C2/3C40/3C2P

Around Null Position
Input Signal $-20 \leftrightarrow +20\%$

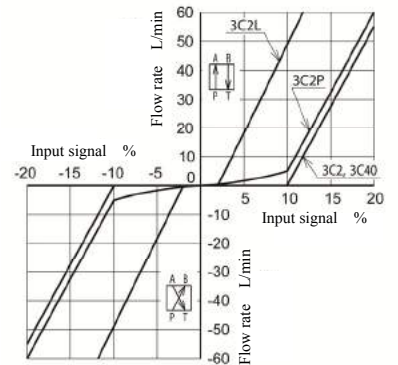
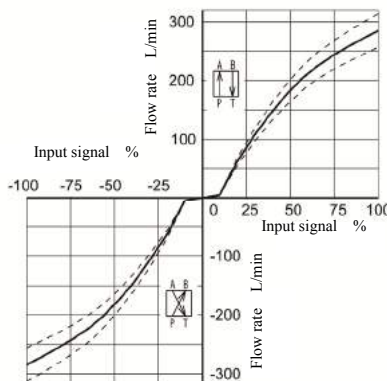
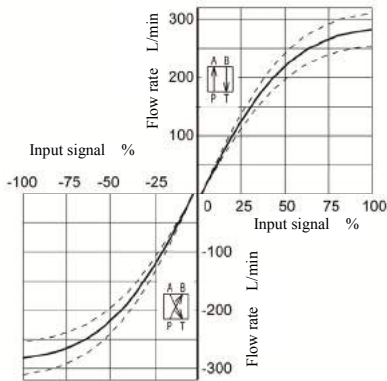

ELDFHG-06EH-350-3C2L

ELDFHG-06EH-350-3C2/3C40/3C2P

Around Null Position
Input Signal $-20 \leftrightarrow +20\%$

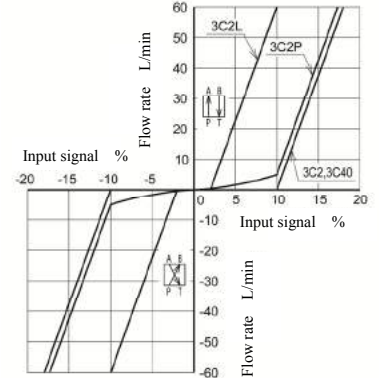
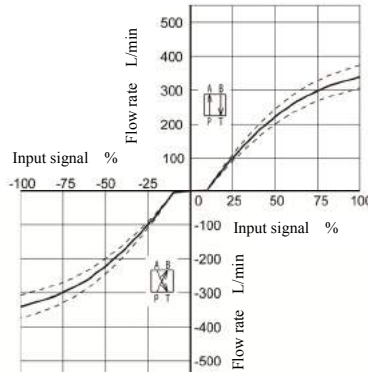
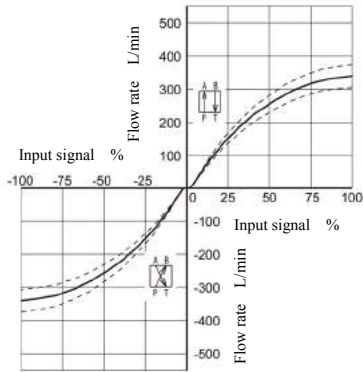

ELDFHG-06EH-500-3C2L

ELDFHG-06EH-500-3C2/3C40/3C2P

Around Null Position
Input Signal $-20 \leftrightarrow +20\%$

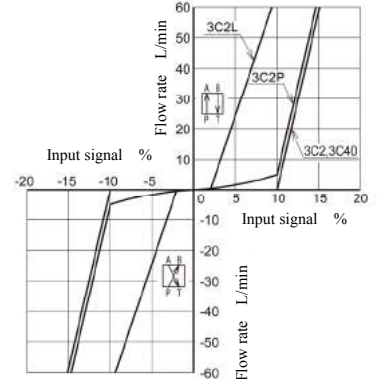
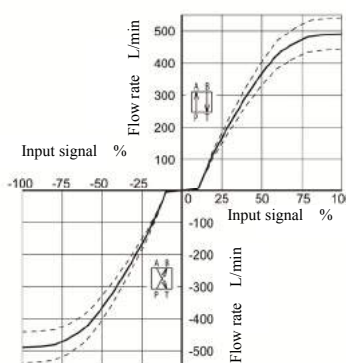
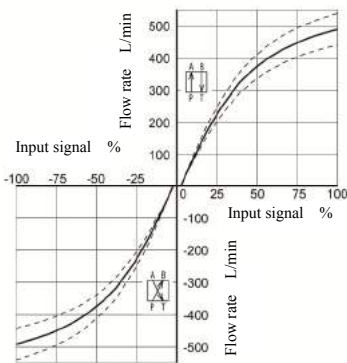

■ Step response (example)

- <Conditions>
- Hydraulic Circuit: Port A/B Closed
 - Supply pressure and Pilot pressure: 14 MPa
 - Input signal: 0⇔100%
 - Viscosity: 30 mm²/s

This value is measured on a per valve basis; the actual step response may differ depending on the actual circuit.

ELDFHG-04EH

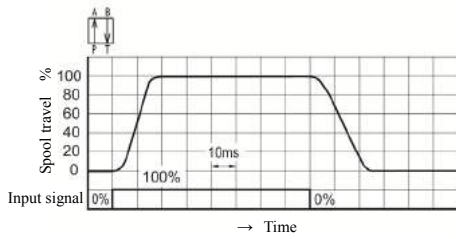

ELDFHG-06EH-350

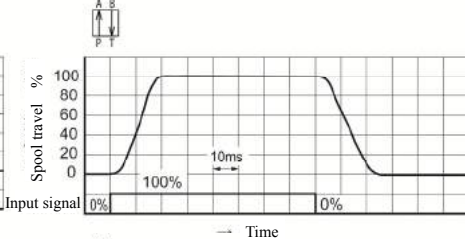

ELDFHG-06EH-500

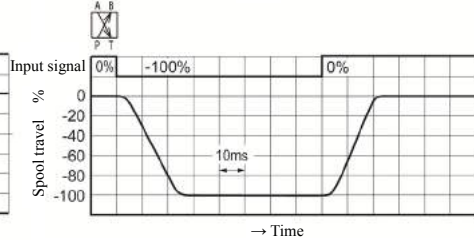
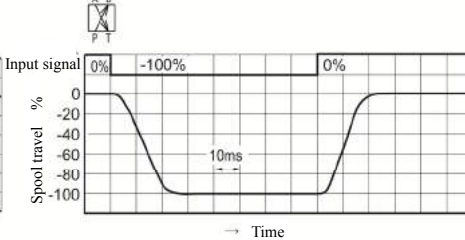
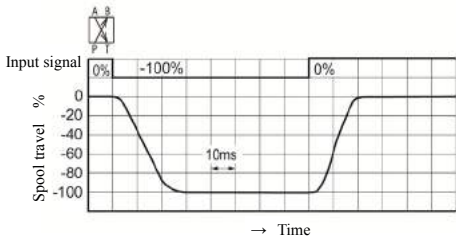
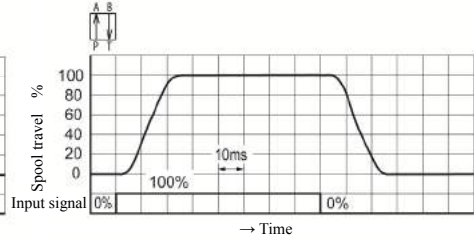

■ Frequency response (example)

- <Conditions>
- Hydraulic Circuit: Port A/B Closed
 - Supply pressure and Pilot pressure: 14 MPa
 - Viscosity: 30 mm²/s

This value is measured on a per valve basis; the actual frequency response may differ depending on the actual circuit.

ELDFHG-04EH

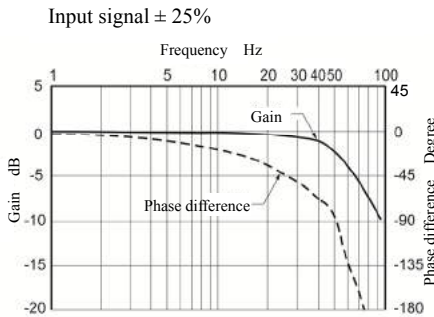

ELDFHG-06EH-350

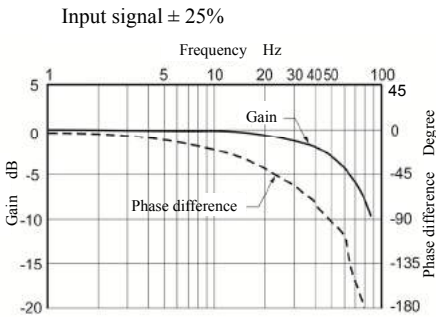

ELDFHG-06EH-500

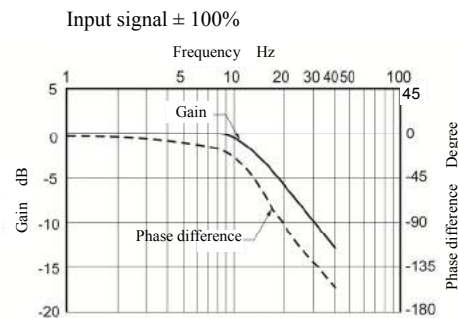
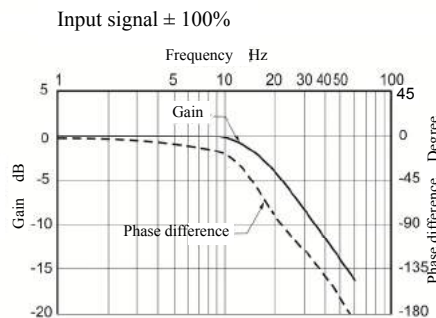
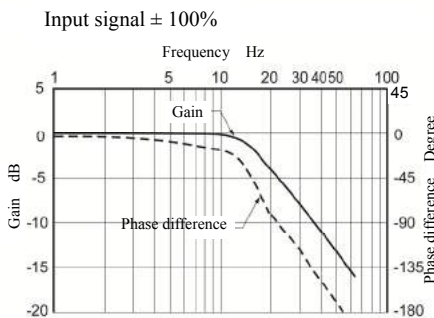
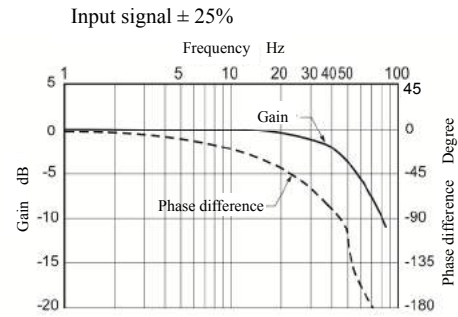

■ Application

Injection molding machines, machine tools, wood processing machines, simulators, etc.

■ Product Release

August 2015 (released)

YUKEN KOGYO CO.,LTD.

Contact

International Sales Department

4-4-34, Kamitsuchidana-Naka, Ayase,
Kanagawa Pref. 252-1113, Japan

Phone: +81-467-77-3111 Fax: +81-467-77-3115

e-mail: int.bd@yuken.co.jp Internet: www.yuken.co.jp